

Chap 4. Steady State Thermal Analysis 穩態熱傳分析

4.1. 前言

本章旨在介紹農業建築的各個組成單元的穩態熱傳計算。

4.2. 透過牆面的熱傳導 Heat Transfer Through Walls

Example 4-1 某牛舍使用 203.2 mm 厚度的水泥磚(三橢圓孔)做牆壁，請估算 R 值以及內外牆的表面溫度，假設室內外溫度分別為 15 與 -5 度 C。(Appendix 4-1, at p399)

The walls of a dairy barn have constructed of (three oval core) concrete blocks 203.2 mm thick (8 in. blocks). Determine the R-value of the wall and estimate the temperatures of the inside and outside surfaces when it is 15 C indoors and -5 C outdoors.

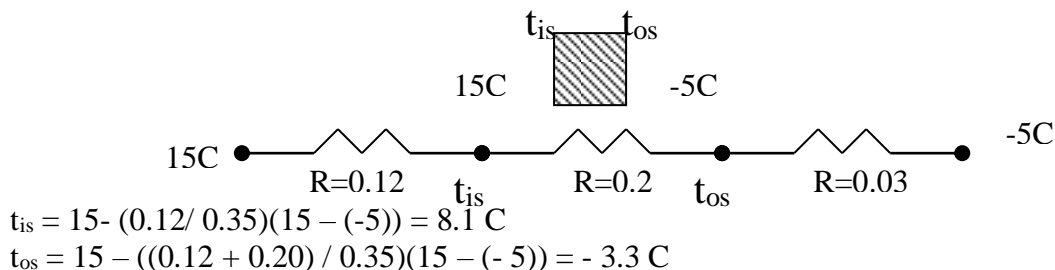

Appendix 3-2, at p388

Thermal Properties of Typical Building and Insulating Materials—Design Values*

Description	Density kg/m ³	Conduc- tivity (λ) W/m·°C	Conduc- tance (C) W/m ² ·°C	Resistance (R)		Specific Heat kJ/ (kg·°C)
				Per meter thickness	For thick- ness listed	
PLASTERING MATERIALS						
Sand aggregate	1680	0.806	—	1.25	—	0.84
Sand aggregate	1680	—	63.05	—	0.016	—
Sand aggregate	1680	—	51.69	—	0.019	—
Sand aggregate on metal lath	—	—	43.74	—	0.023	—
Vermiculite aggregate	720	0.245	—	4.09	—	—
MASONRY MATERIALS						
Concretes						
Cement mortar	1856	0.720	—	1.39	—	—
Gypsum-fiber concrete 87.5% gypsum, 12.5% wood chips	816	0.239	—	4.16	—	0.88
Lightweight aggregates including ex- panded shale, clay or slate; expanded slags; cinders; pumice; vermiculite; also cellular concretes	1920 1600 1280 960 640 480 320	0.749 0.518 0.360 0.245 0.166 0.130 0.101	— — — — — — —	1.32 1.94 2.78 4.09 5.97 7.70 9.92	— — — — — — —	— — — — — — —
Perlite, expanded	640 480 320	0.134 0.102 0.072	— — —	7.50 9.79 13.88	— — —	— — —
Sand and gravel or stone aggregate (oven dried)	2240	1.296	—	0.76	—	0.92
Sand and gravel or stone aggregate (not dried)	2240	1.728	—	0.56	—	—
Stucco	1856	0.720	—	1.39	—	—

MASONRY UNITS

Brick, common ^f	1920	0.720	—	1.39	—	0.80
Brick, face ^f	2080	1.296	—	0.76	—	—
Clay tile, hollow:						
1 cell deep	76.2 mm	—	7.10	—	0.14	0.88
1 cell deep	101.6 mm	—	5.11	—	0.20	—
2 cells deep	152.4 mm	—	3.75	—	0.27	—
2 cells deep	203.2 mm	—	3.07	—	0.33	—
2 cells deep	254.0 mm	—	2.56	—	0.39	—
3 cells deep	304.8 mm	—	2.27	—	0.44	—
Concrete blocks, three oval core:						
Sand and gravel aggregate	101.6 mm	—	7.95	—	0.12	0.92
Sand and gravel aggregate	203.2 mm	—	5.11	—	0.20	—
Sand and gravel aggregate	304.8 mm	—	4.43	—	0.23	—
Cinder aggregate	76.2 mm	—	6.59	—	0.15	0.88
Cinder aggregate	101.6 mm	—	5.11	—	0.20	—
Cinder aggregate	203.2 mm	—	3.29	—	0.30	—
Cinder aggregate	304.8 mm	—	3.01	—	0.33	—
Lightweight aggregate	76.2 mm	—	4.49	—	0.22	0.88
expanded shale, clay, slate	101.6 mm	—	3.81	—	0.26	—
or slag; pumice	203.2 mm	—	2.84	—	0.35	—
or slag; pumice	304.8 mm	—	2.50	—	0.40	—
Concrete blocks, rectangular core: ^h						
Sand and gravel aggregate						
2 core, ^h	203.2 mm, 16.3 kg	—	5.45	—	0.18	0.92
Same with filled cores ^l		—	2.95	—	0.34	0.92
Lightweight aggregate (expanded shale,						
clay, slate or slag, pumice):						
3 core, ^h	152.4 mm, 8.6 kg	—	3.46	—	0.29	0.88
Same with filled cores ^l		—	1.87	—	0.53	—
2 core, ^h	203.2 mm, 10.9 kg	—	2.61	—	0.38	—
Same with filled cores ^l		—	1.14	—	0.89	—
3 core, ^h	304.8 mm, 17.3 kg	—	2.27	—	0.44	—
Same with filled cores ^l		—	0.97	—	1.02	—
Stone, lime or sand		1.800	—	0.56	—	0.80
Gypsum partition tile:						
76.2 • 304.8 • 762.0 mm, solid		—	4.49	—	0.22	0.80
76.2 • 304.8 • 762.0 mm, 4-cell		—	4.20	—	0.24	—
101.6 • 304.8 • 762.0 mm, 3-cell		—	3.41	—	0.29	—

Appendix 3-5, at p397

A. Standard data for still air, as inside a building:

Orientation of surface	Heat Flow Direction	Surface Emittance					
		0.90		0.20		0.05	
		h	R	h	R	h	R
vertical	horizontal	8.29	0.12	4.20	0.24	3.35	0.30
horizontal	upward	9.26	0.11	5.17	0.19	4.32	0.23
	downward	6.13	0.16	2.10	0.48	1.25	0.80
45 degree slope	upward	9.09	0.11	5.00	0.20	4.15	0.24
	downward	7.50	0.13	3.41	0.29	2.56	0.39

B. Moving air, as outside a building, surface in any orientation:

Wind Velocity, m/s	h	R
6.7	34.08	0.030 (for winter)
3.4	22.72	0.044 (for summer)

APPENDIX 4-1

SKETCHES OF COMMON WALL CONSTRUCTION TYPES

Taken in part from the 1985 ASHRAE Handbook of Fundamentals,
American Society of Heating, Refrigerating and Air Conditioning Engineers, Atlanta GA
Used by permission

standard wood-framed outside wall

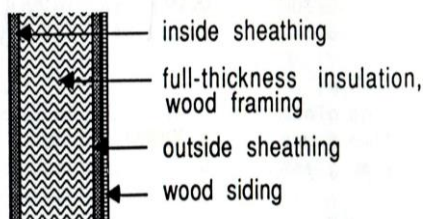

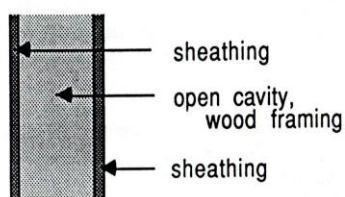
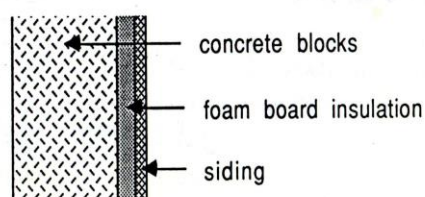
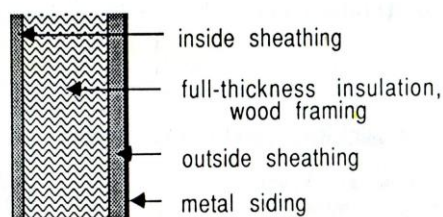
standard wood-framed partition wallinsulated concrete block wallmetal-sided wall with wood framing

Example 4-2 如下圖所示，某木製牆壁內側使用 15.88 mm 厚 Douglas fir plywood 三夾板，外側使用 12.7 mm 厚一般密度的蔬菜纖維板外加 11.11 mm 厚硬木板做裝飾外牆 (siding)。內外側之間的空間填以保溫的玻璃棉。請問是否需填滿整個空間或者是只需填入較小的厚度，假設在冬天所需要的熱阻是 $2 \text{ m}^2\text{K/W}$ 。木框由 88.9 mm 厚，38.1 mm 寬 (2 x 4 牆框木條) 組成。

Note: Between framing : 牆面，Over framing : 支架

A wood-framed wall is to be constructed with an inside sheathing of plywood, an outside sheathing of vegetable fiber board, and plywood siding. A question has arisen whether it will be necessary to specify full-thickness glass wool insulation (which means insulation to fill the wall cavity) or whether a lesser thickness will be sufficient.

The desired wall insulation value is $2 \text{ m}^2\text{K/W}$. Framing members are 88.9mm thick and 38.1 mm wide (2 x 4 wall studs). Inside sheathing is to be 15.88 mm thick Douglas fir plywood, outside sheathing is to be 12.70 mm thick regular density vegetable fiber board, and the siding is to be 11.11 mm thick hardboard. Winter design conditions are assumed.

	R-value, m ² K/W	
	between framing	over framing
inside surface	0.12 (a)	0.12 (a) P397
inside sheathing	0.14 (a)	0.14 (a) P386
wall cavity	<u>2.29 (b)</u>	0.58 (c)
outside sheathing	0.23 (a)	0.23 (a) P386
siding	0.05 (a)	0.05 (a) P387
outside surface	<u>0.03 (a)</u>	<u>0.03 (a)</u> P397
TOTAL	2.86	1.15

1 m² of Insulated materials: R_{insulated}=2.86 m²K/W

0.8 m² of Insulated materials and 0.2 m² of framing: R_{overall} = 2.2 m²K/W

若 R_{overall} = 2.0 m²K/W 則 R_{insulated}=2.45 m²K/W 即可，可減少 0.41 m²K/W。

因只有中空部份(cavity)的 R 值為可調，所以由 2.29 調整為 1.88 (減少 0.41) m²K/W。

Example 4-3 某溫室內安裝於屋簷高度的水平方向的保溫簾 (thermal curtain) 使用兩層單側織上鋁箔 (foil-faced fabric) 的平織(loose-weave) 膠膜間隔 20 mm。假設膠膜厚度不考慮，鋁箔面的表面輻射率為 0.2，另一側為 0.6，兩層膠膜可有四種安裝方式：

1. 鋁箔都朝上
2. 鋁箔都朝下
3. 上層膠膜鋁箔朝上，下層膠膜鋁箔朝下
4. 上層膠膜鋁箔朝下，下層膠膜鋁箔朝上

哪一種有最大的 R 值？

Appendix 3-5, p397. Surface resistance

$$h_s = 4.02 + 5.82\varepsilon \dots\dots\dots 4-1$$

top/bottom surface 的熱阻 R = 1/h_s

E	h _s	R
0.2	5.18	0.19
0.6	7.51	0.13

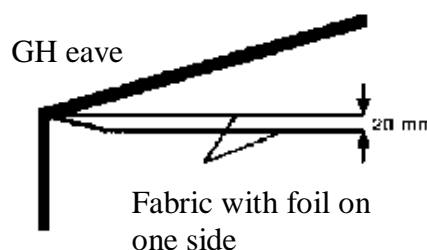

Plain air space 的有效輻射率

ε, side one	ε, side two	effective emittance
0.20	0.20	0.11
0.60	0.60	0.43
0.20	0.60	0.18

已知 effective emittance

由 Appendix 3-6, p398. 可透過內插法查到 R value of the Airspace

當 effective emittance (value of E) = 0.11 (in between 0.05 and 0.2)

$$R = 0.39 + (0.11 - 0.05)(0.30 - 0.39)/(0.20 - 0.05) = 0.35 \text{ m}^2\text{K/W}$$

當 effective emittance (value of E) = 0.43 (in between 0.2 and 0.5)

$$R = 0.30 + (0.43 - 0.20)(0.20 - 0.30)/(0.50 - 0.20) = 0.22 \text{ m}^2\text{K/W}$$

當 effective emittance (value of E) = 0.18 (in between 0.05 and 0.2)

$$R = 0.39 + (0.18 - 0.05)(0.30 - 0.39)/(0.20 - 0.05) = 0.31 \text{ m}^2\text{K/W}$$

Orientation of foil face		R-values			
top layer	bottom layer	top surface	bottom surface	air space	total
up	up	0.19	0.13	0.31	0.63
down	down	0.13	0.19	0.31	0.63
up	down	0.19	0.19	0.22	0.60
down	up	0.13	0.13	0.35	0.61

Appendix 3-6, p398.

THERMAL RESISTANCES OF PLANE AIR SPACES
 Taken from the 1985 ASHRAE Handbook of Fundamentals, American Society of Heating, Refrigerating and Air Conditioning Engineers, Atlanta GA
 Used by permission

Table 2A Thermal Resistances of Plane^a Air Spaces^{b,c}
 $\text{m}^2 \cdot ^\circ\text{C}/\text{W}$

Position of Air Space	Direction of Heat Flow	Air Space ^a		12.7-mm Air Space ^c					19.1-mm Air Space ^c				
		Mean Temp. ^a (°C)	Temp Diff. ^a (°C)	Value of E ^{d,e}					Value of E ^{d,e}				
				0.03	0.05	0.2	0.5	0.82	0.03	0.05	0.2	0.5	0.82
Horiz.	Up	32.2	5.6	0.37	0.36	0.27	0.17	0.13	0.41	0.39	0.28	0.18	0.13
		10.0	16.7	0.29	0.28	0.23	0.17	0.13	0.30	0.29	0.24	0.17	0.14
		10.0	5.6	0.37	0.36	0.28	0.20	0.15	0.40	0.39	0.30	0.20	0.15
		-17.8	11.1	0.30	0.30	0.26	0.20	0.16	0.32	0.32	0.27	0.20	0.16
		-17.8	5.6	0.37	0.36	0.30	0.22	0.18	0.39	0.38	0.31	0.23	0.18
		-45.6	11.1	0.30	0.29	0.26	0.22	0.18	0.31	0.31	0.27	0.22	0.19
45° Slope	Up	32.2	5.6	0.43	0.41	0.29	0.19	0.13	0.52	0.49	0.33	0.20	0.14
		10.0	16.7	0.36	0.35	0.27	0.19	0.15	0.35	0.34	0.27	0.19	0.14
		10.0	5.6	0.45	0.43	0.32	0.21	0.16	0.51	0.48	0.35	0.23	0.17
		-17.8	11.1	0.39	0.38	0.31	0.23	0.18	0.37	0.36	0.30	0.23	0.18
		-17.8	5.6	0.46	0.45	0.36	0.25	0.19	0.48	0.46	0.37	0.26	0.20
		-45.6	11.1	0.37	0.36	0.31	0.25	0.21	0.36	0.35	0.31	0.25	0.20
Vertical	Horiz.	32.2	5.6	0.43	0.41	0.29	0.19	0.14	0.62	0.57	0.37	0.21	0.15
		10.0	16.7	0.45	0.43	0.32	0.22	0.16	0.51	0.49	0.35	0.23	0.17
		10.0	5.6	0.47	0.45	0.33	0.22	0.16	0.65	0.61	0.41	0.25	0.18
		-17.8	11.1	0.50	0.48	0.38	0.26	0.20	0.55	0.53	0.41	0.28	0.21
		-17.8	5.6	0.52	0.50	0.39	0.27	0.20	0.66	0.63	0.46	0.30	0.22
		-45.6	11.1	0.51	0.50	0.41	0.31	0.24	0.51	0.50	0.42	0.31	0.24
45° Slope	Down	32.2	5.6	0.44	0.41	0.29	0.19	0.14	0.62	0.58	0.37	0.21	0.15
		10.0	16.7	0.46	0.44	0.33	0.22	0.16	0.60	0.57	0.39	0.24	0.18
		10.0	5.6	0.47	0.45	0.33	0.22	0.16	0.67	0.63	0.42	0.26	0.18
		-17.8	11.1	0.51	0.49	0.39	0.27	0.20	0.66	0.63	0.46	0.30	0.22
		-17.8	5.6	0.52	0.50	0.39	0.27	0.20	0.73	0.69	0.49	0.32	0.23
		-45.6	11.1	0.56	0.54	0.44	0.33	0.25	0.67	0.64	0.51	0.36	0.28
Horiz.	Down	32.2	5.6	0.44	0.41	0.29	0.19	0.14	0.62	0.58	0.37	0.21	0.15
		10.0	16.7	0.47	0.45	0.33	0.22	0.16	0.66	0.62	0.42	0.25	0.18
		10.0	5.6	0.47	0.45	0.33	0.22	0.16	0.68	0.63	0.42	0.26	0.18
		-17.8	11.1	0.52	0.50	0.39	0.27	0.20	0.74	0.70	0.50	0.32	0.23
		-17.8	5.6	0.52	0.50	0.39	0.27	0.20	0.75	0.71	0.51	0.32	0.23
		-45.6	11.1	0.57	0.55	0.45	0.33	0.26	0.81	0.78	0.59	0.40	0.30
		-45.6	5.6	0.58	0.56	0.46	0.33	0.26	0.83	0.79	0.60	0.40	0.30

88.9

Position of Air Space	Direction of Heat Flow	Air Space		38.1 mm Air Space ^c						88.9 mm Air Space ^c					
		Mean Temp. ^d (°C)	Temp Diff. ^b (°C)	Value of E ^{d,e}						Value of E ^{d,e}					
				0.03	0.05	0.2	0.5	0.82	0.03	0.05	0.2	0.5	0.82		
Horiz	Up	32.2	5.6	0.45	0.42	0.30	0.19	0.14	0.50	0.47	0.32	0.20	0.14		
		10.0	16.7	0.33	0.32	0.26	0.18	0.14	0.27	0.35	0.28	0.19	0.15		
		10.0	5.6	0.44	0.42	0.32	0.21	0.16	0.49	0.47	0.34	0.23	0.16		
		-17.8	11.1	0.35	0.34	0.29	0.22	0.17	0.40	0.38	0.32	0.23	0.18		
		-17.8	5.6	0.43	0.41	0.33	0.24	0.19	0.48	0.46	0.36	0.26	0.20		
		-45.6	11.1	0.34	0.34	0.30	0.24	0.20	0.39	0.38	0.33	0.26	0.21		
45° Slope	Up	32.2	5.6	0.51	0.48	0.33	0.20	0.14	0.56	0.52	0.35	0.21	0.14		
		10.0	16.7	0.38	0.36	0.28	0.20	0.15	0.40	0.38	0.29	0.20	0.15		
		10.0	5.6	0.51	0.48	0.35	0.23	0.17	0.55	0.52	0.37	0.24	0.17		
		-17.8	11.1	0.40	0.39	0.32	0.24	0.18	0.43	0.41	0.33	0.24	0.19		
		-17.8	5.6	0.49	0.47	0.37	0.26	0.20	0.52	0.51	0.39	0.27	0.20		
		-45.6	11.1	0.39	0.38	0.33	0.26	0.21	0.41	0.40	0.35	0.27	0.22		
Vertical	Horiz.	32.2	5.6	0.70	0.64	0.40	0.22	0.15	0.65	0.60	0.38	0.22	0.15		
		10.0	16.7	0.45	0.43	0.32	0.22	0.16	0.47	0.45	0.33	0.22	0.16		
		10.0	5.6	0.67	0.62	0.42	0.26	0.18	0.64	0.60	0.41	0.25	0.18		
		-17.8	11.1	0.49	0.47	0.37	0.26	0.20	0.51	0.49	0.38	0.27	0.20		
		-17.8	5.6	0.62	0.59	0.44	0.29	0.22	0.61	0.59	0.44	0.29	0.22		
		-45.6	11.1	0.46	0.45	0.38	0.29	0.23	0.50	0.48	0.40	0.30	0.24		
45° Slope	Down	32.2	5.6	0.89	0.80	0.45	0.24	0.16	0.85	0.76	0.44	0.24	0.16		
		10.0	16.7	0.63	0.59	0.41	0.25	0.18	0.62	0.58	0.40	0.25	0.18		
		10.0	5.6	0.90	0.82	0.50	0.28	0.19	0.83	0.77	0.48	0.28	0.19		
		-17.8	11.1	0.68	0.64	0.47	0.31	0.22	0.67	0.64	0.47	0.31	0.22		
		-17.8	5.6	0.87	0.81	0.56	0.34	0.24	0.81	0.76	0.53	0.33	0.24		
		-45.6	11.1	0.54	0.62	0.49	0.35	0.27	0.66	0.64	0.51	0.36	0.28		
Horiz.	Down	32.2	5.6	1.07	0.94	0.49	0.25	0.17	1.77	1.44	0.60	0.28	0.18		
		10.0	16.7	1.10	0.99	0.56	0.30	0.20	1.69	1.44	0.68	0.33	0.21		
		10.0	5.6	1.16	1.04	0.58	0.30	0.20	1.96	1.63	0.72	0.34	0.22		
		-17.8	11.1	1.24	1.13	0.69	0.39	0.26	1.92	1.68	0.86	0.43	0.29		
		-17.8	5.6	1.29	1.17	0.70	0.39	0.27	2.11	1.82	0.89	0.44	0.29		
		-45.6	11.1	1.36	1.27	0.84	0.50	0.35	2.05	1.85	1.06	0.57	0.38		
		-45.6	5.6	1.42	1.32	0.86	0.51	0.35	2.28	2.03	1.12	0.59	0.39		

Value of E 由 0.82 降至 0.03, 熱阻可增加近 4 倍

Example 4-4 蘋果冷藏庫的設計目標是要達到 2.5 m²K/W 的熱阻值，已知內外牆使用 101.1 mm 厚的水泥磚，中間需要使用多厚的 PU 發泡板 (polyurethane foam boards) 為絕熱材料？

Design the wall using steady-state analysis to meet this goal.

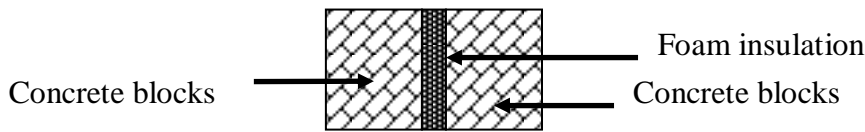

In side surface resistance: 0.12
 Concrete block resistance: 0.12
 Concrete block resistance: 0.12
 outside surface resistance: 0.03 sum = 0.39 m²K/W
 0.12 + 0.12 + 0.12 + 0.03 = 0.39 m²K/W

R value of 2.5 m²K/W is desired. The insulation must provide 2.11 m²K/W

4.3. 透過天花板的熱傳導 Heat Transfer Through Ceilings

Appendix 3-2, at p387

Thermal Properties of Typical Building and Insulating Materials—Design Values*

Description	Density kg/m ³	Conduc- tivity (A) W/m·°C	Conduc- tance (C) W/m ² ·°C	Resistance (R)		Specific Heat kJ/ (kg·°C)
				Per meter thickness	For thick- ness listed	
Board and Slabs						
Cellular glass	136	0.050	—	19.85	—	0.75
Glass fiber, organic bonded	64-144	0.036	—	27.76	—	0.96
Expanded perlite, organic bonded	16.0	0.052	—	19.29	—	1.26
Expanded rubber (rigid)	72.0	0.032	—	31.58	—	1.68
Expanded polystyrene extruded	28.8	0.036	—	27.76	—	1.22
Cut cell surface	28.8-56.0	0.029	—	34.70	—	1.22
Smooth skin surface	16.0	0.037	—	23.25	—	—
Expanded polystyrene, molded beads	20.0	0.036	—	27.76	—	—
24.0	24.0	0.035	—	28.94	—	—
28.0	28.0	0.035	—	28.94	—	—
32.0	32.0	0.033	—	30.19	—	—
24.0	24.0	0.023	—	43.38	—	1.59
Cellular polyurethane ^c (R-11 exp.) (unfaced)	—	—	—	—	—	—
Foil-faced, glass fiber-reinforced cellular	—	—	—	—	—	—
Polyisocyanurate (R-11 exp.) ^d	32.0	0.020	—	49.97	—	0.92
Nominal 12.70 mm	—	—	1.58	—	0.63	—
Nominal 25.40 mm	—	—	0.79	—	1.27	—
Nominal 50.80 mm	—	—	0.39	—	2.53	—
Mineral fiber with resin binder	240	0.042	—	23.94	—	0.71
Mineral fiberboard, wet felted	—	—	—	—	—	—
Core or roof insulation	256-272	0.049	—	20.40	—	—
Acoustical tile	288	0.050	—	19.85	—	0.80
Acoustical tile	336	0.053	—	18.74	—	—
Mineral fiberboard, wet molded	—	—	—	—	—	—
Acoustical tile ^e	368	0.060	—	16.52	—	0.59
Wood or cane fiberboard	—	—	—	—	—	—
Acoustical tile ^e 12.70 mm	—	—	4.54	—	0.22	1.30
Acoustical tile ^e 19.05 mm	—	—	3.01	—	0.33	—
Interior finish (plank, tile)	240	0.050	—	19.85	—	1.34
Cement fiber slabs (shredded wood with Portland cement binder)	400-432	0.072-0.070	—	13.88-13.12	—	—
Cement fiber slabs (shredded wood with magnesia oxysulfide binder)	352	0.082	—	12.15	—	1.30
LOOSE FILL						
Cellulosic insulation (milled paper or wood pulp)	36.8-51.2	0.039-0.046	—	25.68-21.72	—	1.38
Sawdust or shavings	128-240	0.065	—	15.41	—	1.38
Wood fiber, softwoods	32.0-56.0	0.043	—	23.11	—	1.38
Perlite, expanded	—	—	—	—	—	—
32.0-65.6	32.0-65.6	0.039-0.045	—	25.68-22.90	—	—
65-118	65-118	0.045-0.052	—	22.90-19.43	—	—
118-176	118-176	0.052-0.060	—	19.43-16.66	—	—
Mineral fiber (rock, slag or glass)	—	—	—	—	—	—
approx. 95.3-127.0 mm	9.6-32.0	—	—	—	1.94	0.71
approx. 165.1-222.3 mm	9.6-32.0	—	—	—	3.34	—
approx. 190.5-254.0 mm	9.6-32.0	—	—	—	3.87	—
approx. 260.4-349.3 mm	9.6-32.0	—	—	—	5.28	—
Mineral fiber (rock, slag or glass) approx. 83.8 mm (closed sidewall application)	32.0-56.0	—	—	—	2.46	—
Vermiculite, exfoliated	112-131	0.068	—	14.78	—	1.34
64.0-96.0	64.0-96.0	0.063	—	15.75	—	—
FIELD APPLIED						
Polyurethane foam	24.0-40.0	0.023-0.026	—	43.38-36.50	—	—
Ureaformaldehyde foam	11.2-25.6	0.032-0.040	—	24.78-31.58	—	—
Spray cellulosic fiber base	32.0-96.0	0.035-0.043	—	13.11-28.94	—	—
PLASTERING MATERIALS						
Cement plaster, sand aggregate	1865	0.720	—	1.39	—	0.84
Sand aggregate 9.53 mm	—	—	75.54	—	0.014	0.84
Sand aggregate 19.05 mm	—	—	37.83	—	0.026	0.84
Gypsum plaster:	—	—	—	—	—	—
Lightweight aggregate 12.70 mm	720	—	17.72	—	0.056	—
Lightweight aggregate 15.88 mm	720	—	15.17	—	0.069	—
Lightweight agg. on metal lath 19.05 mm	—	—	12.10	—	0.083	—
Perlite aggregate	720	0.216	—	4.65	—	1.34

矽酸鈣板
 (防火)
 6 mm 250 0.004
 8 mm 800 0.15 187.5 6.9 0.0053
 9 mm 166.7 0.006
 10 mm 150 0.007
 12 mm 125 0.008

387

4.4. 透過被覆材料的熱傳導 Heat Transfer Through Glazings

Appendix 4-2, at p400: Overall thermal resistances of glazings.

APPENDIX 4-2
OVERALL THERMAL RESISTANCES OF GLAZINGS

A. Windows (vertical), no indoor shades, no storm sash

Type	Thermal Resistance, m^2K	
	Winter	Summer
Single glass, clear,		
surface emittance of 0.84	0.16	0.17
0.60	0.17	0.18
0.40	0.19	0.20
0.20	0.22	0.23
Insulating glass, double,		
5 mm air space, 3 mm glass	0.29	0.27
6 mm air space, 3 mm glass	0.30	0.29
13 mm air space, 6 mm glass	0.36	0.31
Insulating glass, triple,		
6 mm air space, 3 mm glass	0.45	0.40

B. Windows (vertical), no indoor shades, glass outdoor st with 25 mm air space

Type	Thermal Resistance, m^2K	
	Winter	Summer
Single glass, clear,		
surface emittance of 0.84	0.43	0.36
0.60	0.37	0.29
0.40	0.40	0.29
0.20	0.43	0.36
Insulating glass, double,		
5 mm air space, 3 mm glass	0.48	0.43
6 mm air space, 3 mm glass	0.50	0.45
13 mm air space, 6 mm glass	0.56	0.45
Insulating glass, triple,		
6 mm air space, 3 mm glass	0.67	0.56

C. Adjustment factors for windows (multiply R-values in parts A and B by these factors)

	Wood Frame	Metal Frame
Single glass	1.05 - 1.18	0.91 - 1.00
Double glass	1.00 - 1.11	0.77 - 0.83
Triple glass	1.00 - 1.05	0.67 - 0.77
Storm sash applied over single glass	1.00 - 1.11	0.71 - 0.83
Storm sash applied over double or triple glass	1.00 - 1.05	0.67 - 0.77

. Greenhouse Glazings

Material (includes surface resistance)	Unit Area Thermal Resistance, m ² K/W
Glass, single	0.16
Glass, double, 6 mm air space	0.25
Polyethylene film, single	0.14
Polyethylene film, double, 100 mm space	0.25
Fiberglass reinforced panel	0.15
Double panel, acrylic or polycarbonate	0.35

Notes:

Winter conditions are -18 C outdoor air, 21 C indoor air, and 24 km/hr (6.67 m/s) wind speed.
 Summer conditions are 32 C outdoor air, 24 C indoor air, solar radiation of 782 W/m², and 12 km/hr (3.33 m/s) wind speed.
 Manufacturer's data should be consulted for more accurate data for specific products, especially for thermally improved

F-Clean 塑膠布之光學及熱學性質

熱貫流率 (單層)

品目	厚度 (微米)	光學性能						熱性能	
		可視光 (%)		日射 (%)			紫外線透過率 (%)	日射熱取得率 (η 值)	熱貫流率 (U 值) W / (m ² · K)
		反射率	透過率	反射率	透過率	吸收率			
自然光流滴品	100	6.2	93.4	5.4	94.4	0.2	88.5	0.94	6.6
自然光流滴品	60	5.8	93.9	5.2	94.7	0.1	90.9	0.95	6.7
浮式玻璃	3 mm	8.2	90.2	7.8	85.8	6.3	71.1	0.88	6.0
浮式玻璃	6 mm	7.8	88.9	7.2	80.2	12.6	61.4	0.84	5.9

Note: U 值越小，隔熱效果越好

熱貫流率 (雙層)

品目	厚度 (微米)	光學性能					熱性能		
		可視光 (%)		日射 (%)			紫外線 透過率 (%)	日射 熱取 得率	熱貫流 率 (U 值)
		反射率	透過率	反射率	透過率	吸收率		(η 值)	$W / (m^2 \cdot K)$
自然光 流滴品	100+100	11.5	87.5	10.3	89.4	0.4	79.2	0.90	3.7
自然光 流滴品	100+60	11.5	88.0	10.0	89.7	0.3	81.2	0.90	3.8

注意：表中各光學及熱性能值是經由旭玻璃股份有限公司的測定法所測得。

Example 4-5 範例 4-2 所描述的木框牆壁中間的孔隙內填滿保溫材料，其平均熱阻為 $2.2 \text{ m}^2\text{K/W}$ 。如下圖所示牆壁高 3 m，長 60 m，牆上共有 20 個窗戶，每個窗戶使用厚度 3 mm 的雙層玻璃，中間以 6 mm 空氣層隔開。窗戶使用木框，窗高 0.6 m，窗寬 1 m。請問窗戶本身的熱阻值與牆壁含窗戶的平均熱阻值。註：請以冬季天候狀況進行設計。

$$A_{\text{windows}} = 20(1.0 \times 0.6) = 12 \text{ m}^2$$

$$A_{\text{wall}} = (3 \times 60) - 12 = 168 \text{ m}^2$$

$$180 / R_{\text{average}} = 12 / 0.32 + 168 / 2.20$$



4.5. 透過門的熱傳導 Heat Transfer Through Doors

Flush doors and Overhead (panel) doors

Appendix 4-3, at p401: unit area thermal resistances of doors.

APPENDIX 4-3
OVERALL THERMAL RESISTANCES OF DOORS

A. Wood doors, no storm doors

Type	Thermal Resistance, m ² K/W	
	Winter	Summer
Flush doors		
hollow core, 35 mm thick	0.37	0.39
hollow core, 44 mm thick	0.38	0.40
with single glazing	0.28	0.33
solid core, 35 mm thick	0.45 ✓	0.46
solid core, 44 mm thick	0.53	0.55
with single glazing	0.38	0.40
with double glazing	0.48	0.49
solid core, 57 mm thick	0.65	0.68
with single glazing	0.43	0.44
with double glazing	0.53	0.55

Panel doors		
11 mm panels, 35 mm thick door	0.31 ✓	
11 mm panels, 44 mm thick door	0.33	
with single glazing	0.26	
with double glazing	0.35	
29 mm panels, 44 mm thick door	0.45	
with single glazing	0.29	
with double glazing	0.40	

B. Wood doors, with storm doors, winter conditions only

Type	Thermal Resistance, m ² K/W	
	wood storm door	metal storm
Flush doors		
hollow core, 35 mm thick	0.59	0.55
hollow core, 44 mm thick	0.61	0.55
with single glazing	0.53	0.49
solid core, 35 mm thick	0.68	0.63
solid core, 44 mm thick		
with single glazing	0.61	0.55
with double glazing	0.70	0.65
solid core, 57 mm thick	0.88	0.84
with single glazing	0.65	0.61
with double glazing	0.76	0.70

Panel doors		
11 mm panels, 35 mm thick door	0.53	
11 mm panels, 44 mm thick door	0.55	
with single glazing	0.49	
with double glazing	0.57	
29 mm panels, 44 mm thick door	0.68	
with single glazing	0.52	
with double glazing	0.63	

Example 4-6 範例 4-5 所述的牆壁擬再增加兩個門，第一為高架門 (overhead door, garage door) 高、寬各為 2.5 與 3 m，第二為平門 (flush door)，又稱拉門，高、寬各為 2.5 與 1 m。前者使用 11 mm 厚的門板與 35 mm 厚的外框；後者使用 35 mm 厚實心門板。兩個門都沒有外加防爆窗。請計算牆壁的平均熱阻。

$$180 / R_{\text{avg}} = 12 / 0.32 + 158 / 2.20 + 2.5 / 0.45 + 7.5 / 0.31$$

$$R_{\text{avg}} = 1.29 \text{ m}^2\text{K/W}$$

$$2.86 \text{ m}^2\text{K/W} \rightarrow \underset{\text{framing}}{2.20} \rightarrow \underset{\text{windows}}{1.58} \rightarrow \underset{\text{doors}}{1.29}$$

4.6. 透過地板的熱傳導 Heat Transfer Through Floors on Grade

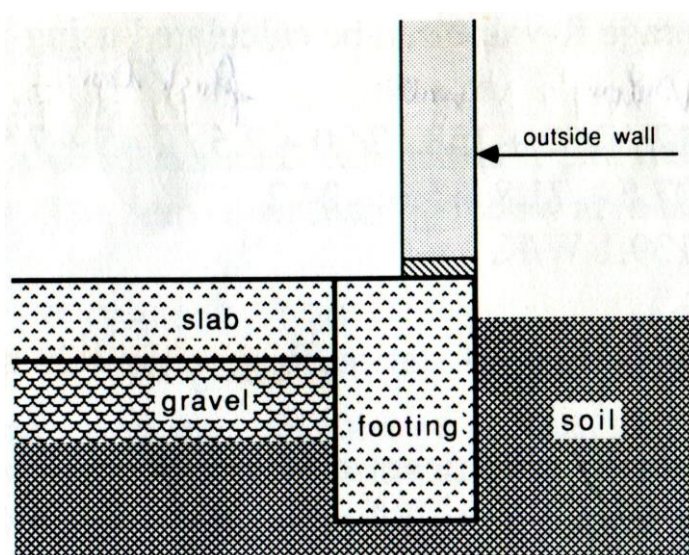

$$q_{\text{floor}} = FP(t_{\text{inside}} - t_{\text{outdoors}}), \dots\dots\dots 4-2$$

其中，P 為地板週長；F 為週長相關的熱損失因子（一般需透過現場試驗來決定數值）。

F 值，W/mK	狀況
1.4~1.6	地下未保溫與空間未加熱
0.8~0.9	如圖 4-1 所示的使用熱阻為 0.95 m ² K/W 的材料做好保溫

4.7. 透過地下室牆面與地板的熱傳導 Heat Transfer Through Basement Walls and Floors

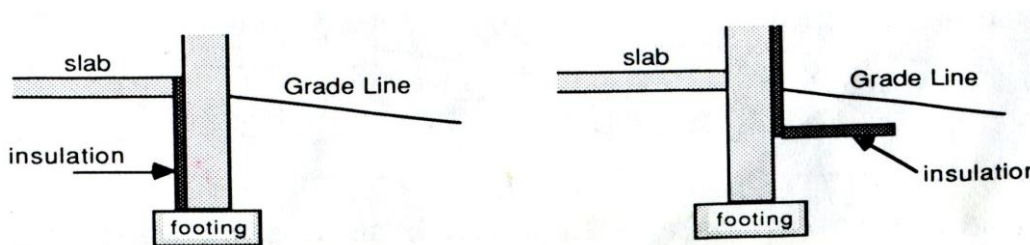
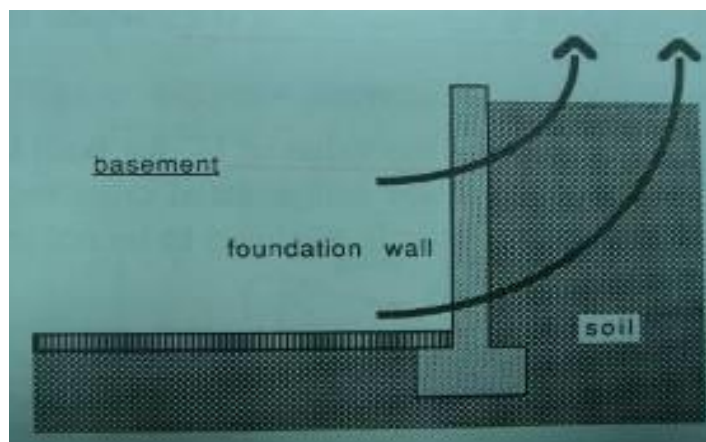

Figure 4-1. Examples of perimeter insulation placement.

$$q_{\text{ground}} = U' (t_{\text{inside}} - t_{\text{ground}}), \dots\dots\dots 4-3$$

Example 4-7 位於北緯 45 度，西經 120 度美國華盛頓州的某水果農場打算在包裝工作室 (packing shed) 建一間地下室做儲藏空間，地下室長寬各為 8.5 x 12 m，地下室地板在地下深度 (below grade) 為 1.8 m。當地的年平均氣溫為 12 度 C，地下室需維持 15 度 C 且四週牆壁與地板均不打算作保溫，請計算此地下室經由四壁與地板流失熱量的速率。

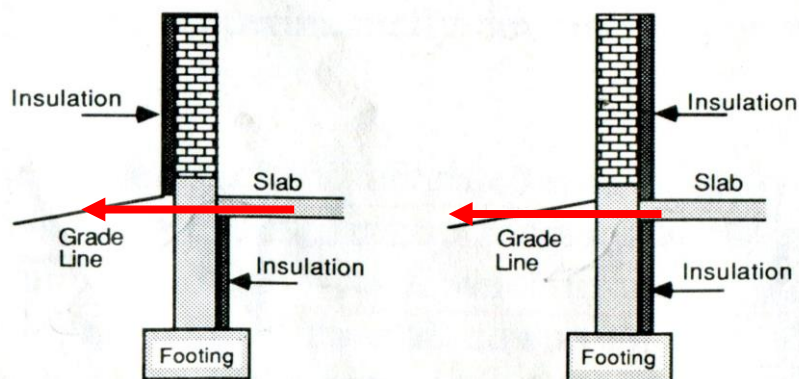

Figure 4-2. Examples of insulation added to slab floors and footings which form thermal bridges.

p.122 更正

$$U_{\text{average}} = (2.33 + 1.26 + 0.88 + 0.67 + 0.54 + 0.45) / 6 = 1.02 \text{ W/m}^2\text{k}$$

$$= 1.02 \text{ W/m}^2\text{k} \times 1.8 \text{ m}^2/\text{m} = 1.84 \text{ W/mK}$$

$$U'_{\text{wall}} = 1.02 \text{ W/m}^2\text{k} \times 1.8 \text{ m} \times 41 \text{ m} = 75 \text{ W/K}$$

$$U'_{\text{floor}} = 0.14 \text{ W/m}^2\text{k} \times 102 \text{ m}^2 = 14 \text{ W/K}$$

$$U'_{\text{basement}} = 75 + 14 = 89 \text{ W/K}$$

$$Q_{\text{ground}} = 89 * (15 - 2) = 1157 \text{ W}$$

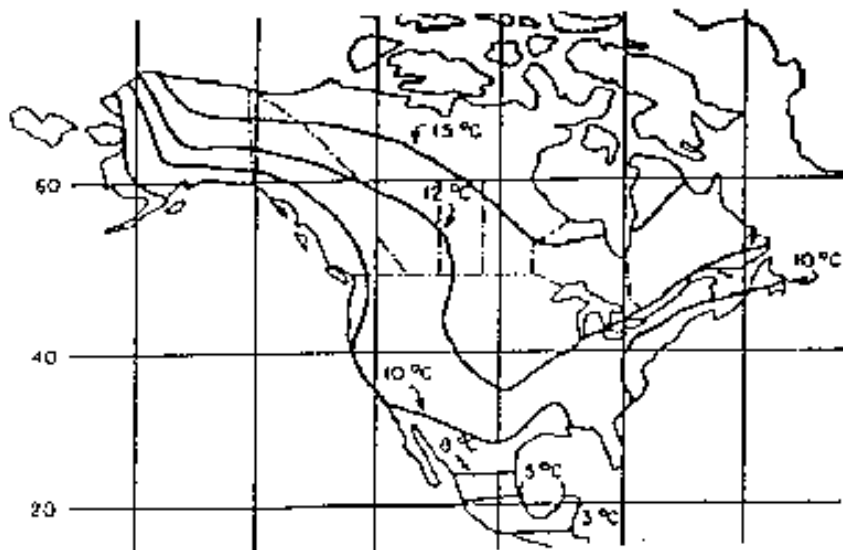

4.7.1. RVALUE 程式 (DOS 版軟體)

需要 DOSBOX 軟體

將 RVALUE.exe 存於桌面的 dd 目錄內。

安裝 DOSBOX 之後執行程式，出現黑色背景的 DOS 視窗，在 DOS 視窗內先執行

Mount C: C:\users\user\desktop\dd

C:

dir

可出現 dd 目錄內的所有檔案，其中，.exe 為可執行的程式

4.8.

Table 4-1. Heat loss conductance for basements χ

<u>Through walls</u>				
Depth below grade	Conductance, W/m^2K , for wall insulated by			
	uninsulated	R = 0.73	1.47	2.20 m^2K/W
0 - 0.3 m	2.33	0.86	0.53	0.38
0.3 - 0.6	1.26	0.66	0.45	0.36
0.6 - 0.9	0.88	0.53	0.38	0.30
0.9 - 1.2	0.67	0.45	0.34	0.27
1.2 - 1.5	0.54	0.39	0.30	0.25
1.5 - 1.8	0.45	0.34	0.27	0.23
1.8 - 2.1	0.39	0.30	0.25	0.21

<u>Through the floor, conductance in W/m^2K</u>				
Depth of floor below grade	Minimum width of basement, m			
	6.0	7.3	8.5	9.7
1.5 m	0.18	0.16	0.15	0.13
1.8	0.17	0.15	0.14	0.12
2.1	0.16	0.15	0.13	0.12

要計算一棟建築物外殼的總熱傳導 $\sum UA$ ，需累計所有地面上建物與地下建物的牆壁、天花板、門、窗等的熱傳導數值。本章前面各節已經介紹各自的計算方式。

好設計需考量多種可行性，搭配成本考量達到設計需求就是做最佳化設計，譬如絕熱材料選擇何種材質，窗戶要選擇單層還是雙層玻璃，選擇同一種或幾種保溫材料來搭配。諸如此類種種分析需要搭配軟體來計算會方便許多。

PROGRAM R-VALUE

This program calculates the overall R-Value of the walls, ceiling, doors, and windows of a single air space building. The effect of framing in the walls and ceiling is included.

This is not a general purpose program to calculate heat loss from buildings because of the following assumptions:

1. Only a single type (your choice) of window is permitted.
2. Only a single type (your choice) of door is permitted.
3. Only a single type (your choice) of wall construction is permitted.
4. Only a single type (your choice) of ceiling construction is permitted.
5. Framing as a fraction of the ceiling area is fixed at 12%, and is always 38x90 mm lumber (2x4s).
6. Wall framing can be only 38x90 mm (2x4s) or 38x140 mm (2x6s).
7. Wind speed at the outside surface of the wall is fixed at 6.7 m/s.

press any key to continue

PROGRAM R-VALUE DATA INPUT

When using this program, you will be asked to decide on the following:

1. the type of window and its area, and winter or summer conditions;
2. the type of door and its area, and winter or summer conditions;
3. the type of ceiling sheathing and insulation, and its area;
4. the type of material in four wall layers: the inside sheathing, insulation, outside sheathing, and siding.
5. the outside perimeter of the building and wall height.

NOTE: although the program expects four layers in the wall, your wall need not have that many. For example, if you want a concrete block wall, which is only one layer, specify layer 1 as an "other" material, enter its R-Value, and specify the other three layers as "other" with R-Values = 0.0.

press any key to continue

Doors are described in section 4-5; door R-values are listed in Appendix 4-3.

Choose the type of door
you will use

TYPE? 2

Winter (1) or Summer (2)? 1

Door area is: 20.0 m²
Door R-Value is: 0.33 m²K/W
Door UA value is: 60.6 W/K

Do you wish to change the
door data (Y,N)?

The following doors are available

1. 35 mm panel door, 11 mm panels
2. 44 mm panel door, 11 mm panels
3. 44 mm solid door, no storm
4. 57 mm solid door, no storm
5. 35 mm hollow core, no storm
6. 44 mm hollow core, no storm
7. 35 mm solid, metal storm
8. 57 mm solid, metal storm
9. 35 mm hollow, metal storm
10. 44 mm hollow, metal storm
11. 44 mm sol., no storm/single gl.
12. 57 mm sol., no storm/single gl.
13. 44 mm sol., mtl strm/single gl.
14. 57 mm sol., mtl strm/single gl.
15. Other

Ceiling heat loss is described in Section 4-3, with R-values in Appendix 3-2.

Here is the ceiling you designed.

The area is 500.0 m²
 The R-Value is 3.10 m²K/W
 The UA value is 161.3 W/K

The framing is fixed at 12% of the total ceiling area, and is comprised of 38x90 mm softwood.

Do you wish to change the ceiling data (Y,N)?

Windows are described in section 4-4, with R-Values in Appendix 4-2.

Choose the type of window you will use

TYPE? 1

Winter (1) or Summer (2)? 1

Window area is: 108.0 m²
 Window R-Value is: 0.16 m²K/W
 Window UA value is: 675.0 W/K

Do you wish to change the window data (Y,N)?

The following windows are available

1. Single glass, 0.84 emittance with storm sash
2. Single glass, 0.20 emittance with storm sash
3. Single glass, 0.20 emittance with storm sash
4. Double glass, 6 mm air space with storm sash
5. Double glass, 6 mm air space with storm sash
6. Triple glass, 6 mm air space with storm sash
7. Triple glass, 6 mm air space with storm sash
8. with storm sash
9. Other

NOTE: It is suggested you use the adjustment factors listed in Appendix 4-2 to calculate R-values more accurately and use "Other".

Wall heat loss is described in Section 4-2, with R-Values in Appendix 3-2.

Now enter perimeter of the outside wall, and its height.

Perimeter, m: ? 120

Height, m: ? 3

Now enter the percentage of the wall which is framed.
 (normally between 12 and 20%)

Framing factor, %, is: 20

Do you wish to change the perimeter, height, or framing factor data (Y/N)?

RESULTS			
Component	Area	R-Value	UA Value
Doors	20.0	0.33	60.6
Windows	108.0	0.16	675.0
Ceiling	500.0	3.10	161.3
Wall	232.0	2.52	92.2

Combined	860.0	0.87	989.1

Do you wish to run this program again <y/n>?

Example 4-8 欲建造一棟長寬高各為 10 x 50 x 3 m 的建築物，窗戶使用單層玻璃 (single glass)，一般的輻射率 (normal emittance)。建築前後會各有一道 2.5 x 4 m, 厚度 44 mm 的門，選用厚度 11 mm 的門板。天花板內側使用 15.88 mm 三夾板並以 150 mm 礦物纖維毯 (mineral fiber blanket) 做隔熱材料。四壁內側使用 12.7 mm 三夾板，外側使用 19.8 mm 一般密度的蔬菜纖維板，內外夾牆使用厚度 88.9 mm 的礦物纖維毯為保溫材料。牆壁の木框佔有牆壁面積的 20 %。Develop a graph to show the effect of glazing area on the overall R-value of the building. Graph the building R-value as a function of glazing area for a glazing area ranging from 0% to 30% of the gross wall area. Assume winter conditions.

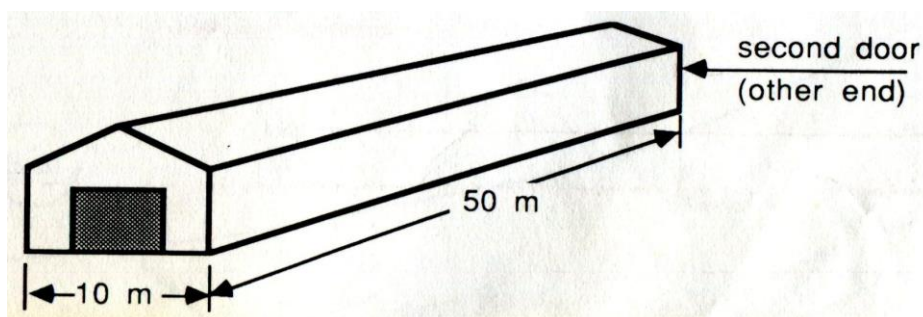

Gross wall area = 3 m x 120 m = 360 m²

Glass Area, %	Glass Area, m ²	Building R-value
0	0	2.41 m ² K/W
5	18	1.86
10	36	1.51
15	54	1.28
20	72	1.10
25	90	0.97
30	108	0.87

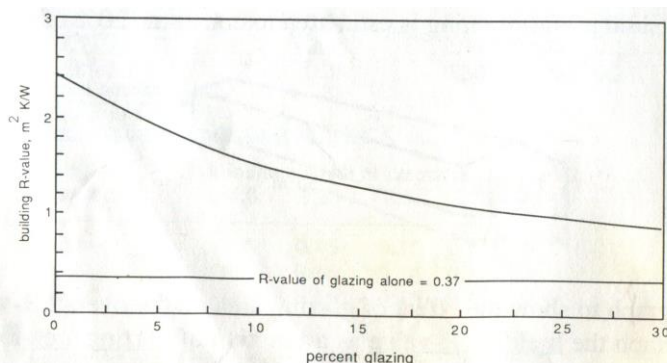
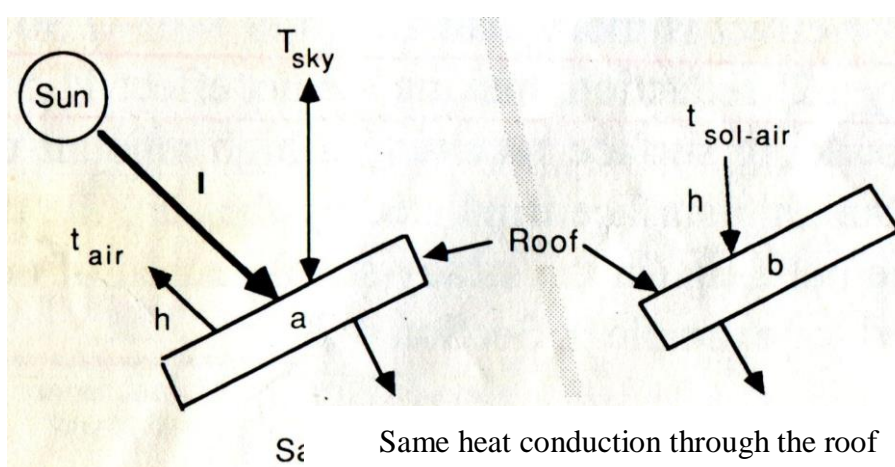

Figure 4-4. Average R-Value of the structural cover of the building described in Example 4-8 as a function of the percentage of the wall devoted to glazing.

4.9. Sol-Air 溫度 (tsa)



An energy balance on the surface contains, as fluxes on the upper surface,
 $q = h * (t_a - t_w) + \alpha * I + \epsilon_w * \sigma * (T_{sky}^4 - T_w^4), , \dots\dots\dots 4-4$
 $q = h * (t_a - t_w) + \alpha * I - \epsilon * \Delta R, \dots\dots\dots 4-5$

定義 $q = h * (t_{sa} - t_w), \dots\dots\dots 4-6$

$t_{sa} = t_a + (\alpha * I - \epsilon * \Delta R) / h, \dots\dots\dots 4-7$

$t_{sa} = t_a + (\alpha * I - 6 * \epsilon * \cos\Phi * (10 - \Omega)) / h, \dots\dots\dots 4-8$

其中， Φ is the tilt angle of the surface

Ω is the cloudiness factor, ranging from 0 for a clear day, to 10 for complete cloud cover.

Example 4-9 某建築物的屋頂斜率為 1:3，受 500 W/m^2 的太陽輻射，空氣溫度為 $28 \text{ }^\circ\text{C}$ ，晴天，屋頂的太陽能吸收率 (solar absorptance) 為 0.8，熱輻射率 (thermal emittance) 為 0.95，外表面的對流熱傳係數 (surface convective coefficient) 為 $30 \text{ W/m}^2\text{K}$ ($R_{os} = 0.03 \text{ m}^2\text{K/W}$)。請計算 solar-air 綜效溫度，並與實際空氣溫度作比較。

$t_{sa} = 28 + [(0.80) (500\text{W/m}^2) - (6 \text{ W/m}^2) (0.95) (\cos(18.43^\circ)) (10 - 0)]/30 \text{ W/m}^2\text{K}$
 $= 39.5$ ，比空氣溫度高出 $11.5 \text{ }^\circ\text{C}$

4.10. 熱交換器

4.10.1. Overall Heat Transfer

$$q'' = \frac{t_b - t_a}{1/h_a + x/k + 1/h_b} \dots\dots\dots 4-9$$

$$q = U * A * \Delta t_m \dots\dots\dots 4-10$$

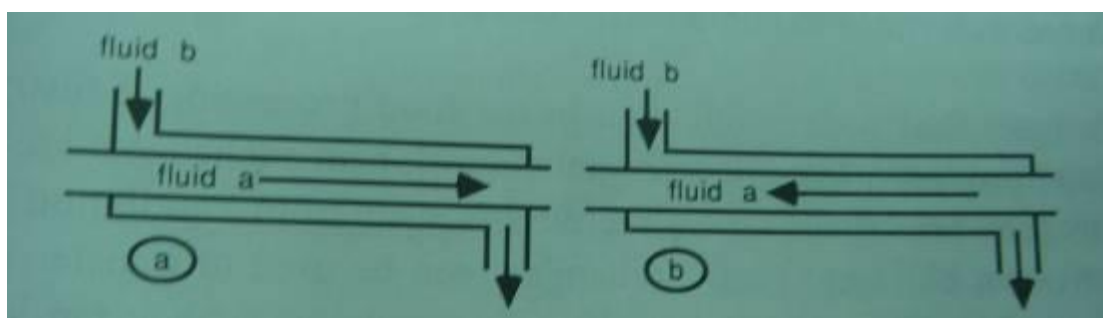
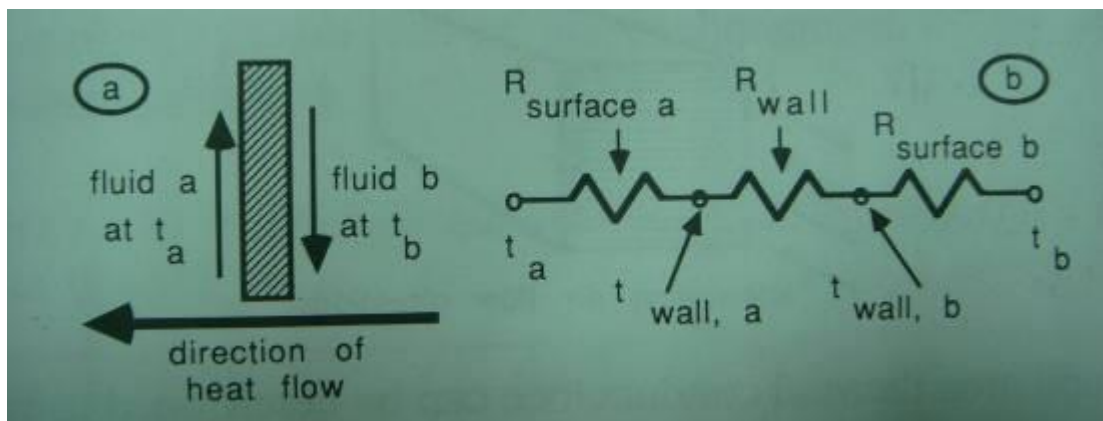

4.10.2. Overall Heat Transfer Coefficient

Example 4-10 如圖所示熱交換器用來針對進入小牛舍的空氣做預熱，此熱交換器使用 0.5 mm 厚的鍍鋅金屬板平行堆疊，風量率為 0.25 m³/s，請求出此熱交換器的 U 值。

A heat exchanger is to be designed and locally fabricated to prewarm ventilation air for a calf nursery. The exchanger will be built of parallel plates of 0.5 mm thick galvanized sheet metal. Dimensions are as shown and the airflow rate in each channel is to be approximately 0.25 m³/s. Determine the average unit area thermal conductance (U) for the exchanger.

$$h = cG^{0.8}D^{-0.2}$$

$$D = 4(0.125 \text{ m}^2)/(2.25 \text{ m}) = 0.222 \text{ m}$$

$$G = \rho V / A = (1.10 \text{ kg/m}^3)(0.25 \text{ m}^3/\text{s})/(0.125 \text{ m}^2) = 2.2 \text{ kg/m}^2\text{s}$$

$$h = (3.10)(2.2 \text{ kg/m}^2\text{s})^{0.8}(0.222 \text{ m})^{-0.2} = 7.87 \text{ W/m}^2\text{K}$$

$$U = 1/[(1 / 7.87 \text{ W/m}^2\text{K}) + (0.0005 \text{ m} / 45.3 \text{ W/mK}) + (1 / 7.78 \text{ w/m}^2\text{K})]$$

$$= 3.94 \text{ W/m}^2\text{K}$$

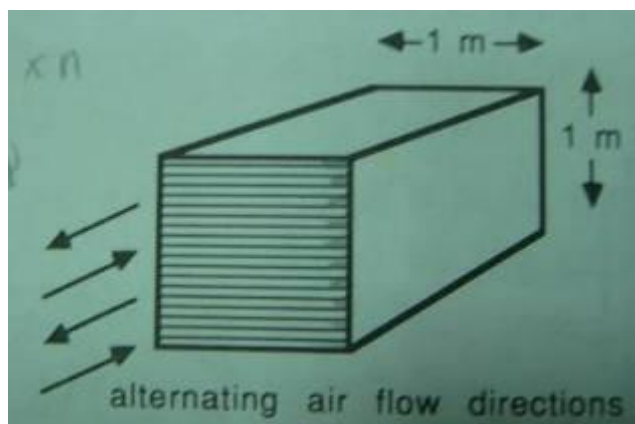

4.10.3. Logarithmic Mean Temperature Difference (LMTD)

$$\Delta t_m = \frac{(t_{h2} - t_{c2}) - (t_{h1} - t_{c1})}{\ln[(t_{h2} - t_{c2}) / (t_{h1} - t_{c1})]} \dots\dots\dots 4-11$$

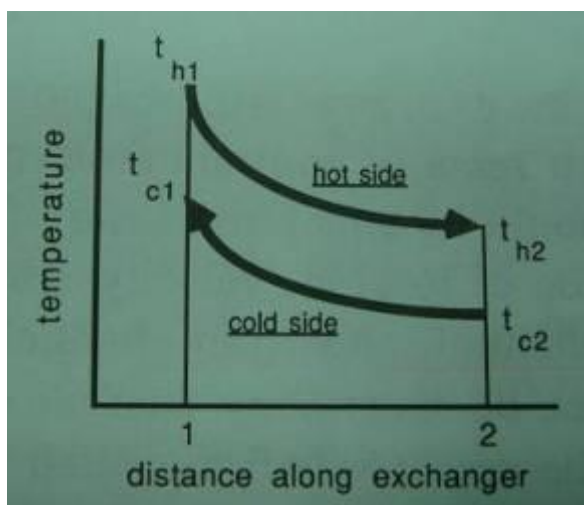

Example 4-11 某熱水對空氣的熱交換器用來給溫室加溫，熱水進出溫度分別為 80 與 60 度 C，流量為 0.05 kg/s，空氣流量為 0.4165 kg/s，進出溫度為 20 與 30 度 C，該熱交換器單位面積的熱傳遞係數為 25 W/m²K，請問需要的熱交換面積有多少？

A heat exchanger is used to transfer heat from hot water to recirculated air within a greenhouse. Hot water arrives at the exchanger at 80 C, and leaves at 60 C, and flows at a rate of 0.05 kg/s. Air flows through the exchanger at a rate of 0.4165 kg/s, and is heated from 20 C to 30 C. The measured unit area thermal conductance of the heat exchanger is 25 W/m²K (this high rate is achieved using fins on the air side of the exchange surface).

What area of heat exchange is needed to achieve these conditions?

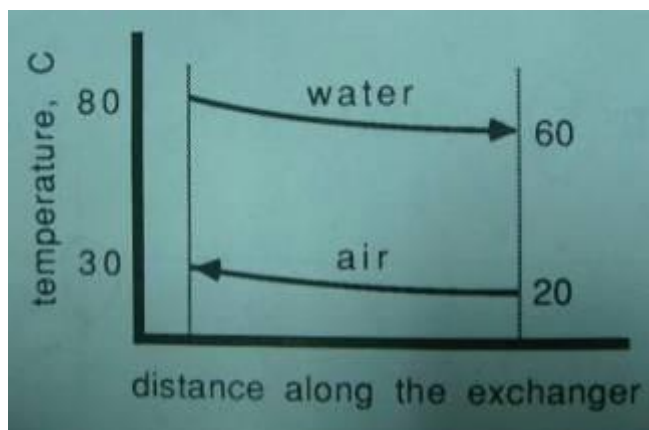

$$q = mc_p \Delta t$$

$$LMTD = \frac{(80 - 30) - (60 - 20)}{\ln\left(\frac{80 - 30}{60 - 20}\right)} = 44.81K$$

$$q = UA(LMTD)$$

$$A = q / [U(LMTD)] = (4,190 \text{ J/s}) / (25 \text{ W/m}^2\text{K})(44.81 \text{ k}) = 3.74 \text{ m}^2$$

4.10.4. Heat Exchanger Effectiveness and the NTU Method

The effectiveness (ϵ) of a heat exchanger is defined as

$$\epsilon = q_{\text{actual}} / q_{\text{max}} \dots\dots\dots 4-12$$

其中， q_{actual} : actual rate of heat transfer

q_{max} : maximum possible rate of heat transfer

$$q_{\text{actual}} = m_h c_h \Delta t_h \text{ or } m_c c_c \Delta t_c \dots\dots\dots 4-13$$

$$q_{\text{max}} = (mc)_{\text{min}} (t_{h, \text{inlet}} - t_{c, \text{inlet}}) \dots\dots\dots 4-14$$

Eq 4-15,... 4-18 , given C and NTU, derive ϵ

其中，NTU: number of transfer units = $UA/(mc)_{\text{min}}$, can be used to indicate the relative size of the heat exchanger.

$$C = (mc)_{\min} / (mc)_{\max}$$

Eq 4-21, ... 4-24, given C and ϵ , derive NTU

parallel flow: $NTU = \frac{-\ln[1 - (1 + C)\epsilon]}{1 + C}$

counter flow: $NTU = (C - 1)^{-1} \ln\left(\frac{\epsilon - 1}{\epsilon C - 1}\right)$

counter flow, $C = 1$: $NTU = \epsilon / (1 - \epsilon)$

all exchangers, $C = 0$: $NTU = -\ln(1 - \epsilon)$

Example 4-12 某溫室使用鄰近的火力發電廠的冷卻水來提供熱能，30 度 C 熱水流經反向流熱交換器，流量率為 2.5 kg/s 的空氣通過熱交換器溫度由 18 度提高至 27 度 C。熱交換器的面積為 100 m²，熱傳遞係數為 50 W/m²K。起問熱水的流量率必須達到多少才能提供上述所需之熱能？

Warm water from the cooling condenser of a power generating station is to provide heat for a large greenhouse range. The warm water flows through counter flow heat exchangers (many exchangers operating in parallel) and greenhouse air is heated by being circulated through the exchangers. Warm water is available at 30 C and greenhouse air is to be heated from 18 C to 27 C. Air flows through the exchanger at a mass flow rate 2.5 kg/s. The heat exchanger surface area is 100 m² and the average unit area thermal conductance (U) is 50 W/m²K.

At what rate must water be pumped through the exchanger to provide this amount of air heating?

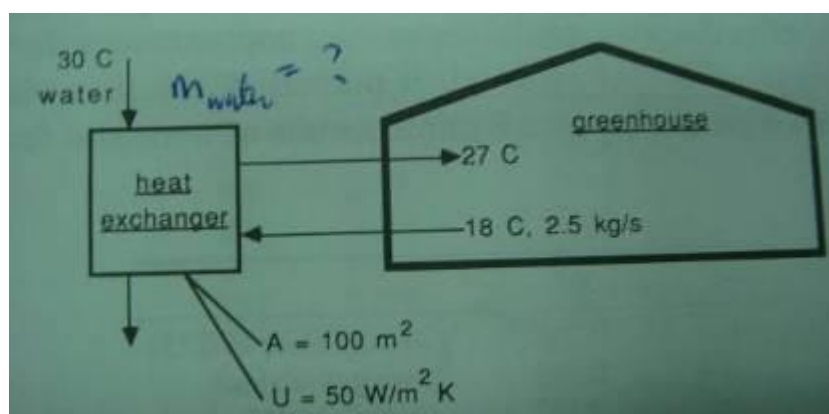

$$(mc)_{\min} = (2.5 \text{ kg/s}) (1006 \text{ J/kg K}) = 2515 \text{ J/sK}$$

$$q_{\text{air}} = (2515 \text{ J/sK})(27 \text{ C} - 18 \text{ C}) = 22,635 \text{ W}$$

$$NTU = UA / (mc)_{\min} = (100 \text{ m}^2) (50 \text{ W/m}^2\text{K}) / (2515 \text{ J/sK}) = 1.99$$

$$\epsilon = \frac{\text{actual temperature change}}{\text{maximum possible temperature change}} = \frac{27\text{ C} - 18\text{ C}}{30\text{ C} - 18\text{ C}} = 0.75$$

$$(mc)_{\max} = (mc)_{\min} / C = 2515\text{ J/sK} / 0.61 = 4123\text{ J/sK}$$

$$m_{\text{water}} = (4123\text{ J/sK}) / (4180\text{ J/kg K}) = 0.986\text{ kg/s}$$

$$\Delta t_{\text{water}} = (22,635\text{ J/s}) / [(0.986\text{ kg/s})(4180\text{ J/kg K})]$$

Water exits the exchanger at $30\text{ C} - 5.5\text{ K} = 24.5\text{ C}$

C	ϵ	
0.5	0.773	(already close to 0.75)
0.4	0.793	(wrong direction)
0.6	0.753	(looking better)
0.65	0.742	(too far)
0.62	0.748	(still too far)
0.61	0.750	(good enough for me)

Example 4-13 重複上題，假設熱水溫度為 35 度 C 而非 30 度 C 時。

Reconsider Example 4-12 and determine the required water pumping rate when water enters the heat exchanger at a temperature of 35 C instead of 30 C.

$$\epsilon = (27\text{ C} - 18\text{ C}) / (35\text{ C} - 18\text{ C}) = 0.53$$

C	ϵ	(as before)
0.5	0.773	
0.7	0.731	
0.9	0.688	
0.99	0.668	(not even close)

$m\dot{c}_{\text{water}}$	C	NTU = UA/C_{\min}	Δt_{water}	$\epsilon =$ $\Delta t_{\text{water}}/17$	ϵ by Eq. 4-16
2000	0.795	2.500	11.32 K	0.666	0.766
1500	0.596	3.333	15.09	0.888	0.876
1600	0.636	3.125	14.15	0.832	0.853
1550	0.616	3.226	14.60	0.859	0.865
1530	0.608	3.268	14.79	0.870	0.869
1533	0.610	3.262	14.77	0.869	0.868
1534	0.610	3.259	14.76	0.868	0.868

由於 $m\dot{c}_{\text{air}} = 2515$ 並非限制因子，所以 $m\dot{c}_{\text{water}} < 2515$ ，如上表，由 2000 起算

$$C = m\dot{c}_{\text{water}} / 2515\text{ J/sK}$$

$$\text{NTU} = (50\text{ W/m}^2\text{K})(100\text{m}^2) / m\dot{c}_{\text{water}}$$

$$\Delta t_{\text{water}} = (22,635\text{ J/s}) / m\dot{c}_{\text{water}}$$

$$\varepsilon = \Delta t_{\text{water}} / 17$$

$$\varepsilon = f(\text{NTU}, C) \dots \text{qe. 4-16}$$

以上兩個 ε 應該相同，傳統做法可透過疊代運算如上表所示。

請自我練習本例題，使用 excel 的目標求解功能，假設兩個 ε 為 $\varepsilon_1, \varepsilon_2$ 。令兩者之差為 0 時，求 m_{Cwater} 之值。

求解得出 $m_{\text{Cwater}} = 1534 \text{ J/sK}$ 之後，除以 c_{water} 可得

$$m_{\text{water}} = (1534 \text{ J/sK}) / (4180 \text{ J/kg K}) = 0.367 \text{ kg/s}$$

比較

	Example 4_12	Example 4_13
入口水溫	30	35
出口水溫	24.5	20.24
溫差	5.5	14.76 溫差大
流量, kg/s	0.986	0.367 馬達小
ε	0.75	0.868 效率高

4.10.5. XCHANGER 程式 (DOS 版軟體)

需要 DOSBOX 軟體

將 XCHANGER.exe 存於桌面的 dd 目錄內。

安裝 DOSBOX 之後執行程式，出現黑色背景的 DOS 視窗，

在 DOS 視窗內先執行

Mount C: C:\users\user\desktop\dd

C:

dir

可出現 dd 目錄內的所有檔案，其中，.exe 為可執行的程式

Example 4-14 使用 XCHANGER 程式，重新計算 範例 4-12，輸入條件與計算結果如下圖所示：

```

HERE ARE THE RESULTS OF THE CALCULATIONS...

Given Parameters
Cold Side...
flow rate, kg/s: 2.50
entering temp., C: 18.00
exiting temp., C: 27.00
spec. heat, J/kgK: 1006

Warm Side...
entering temp., C: 30.00
spec. heat, J/kgK: 4180

Exchanger UA, W/K: 5000
Exchanger Type: counter

Calculated Parameters
Warm Side...
flow rate, kg/s: 0.9846
exiting temp., C: 24.500

Limiting Side: cold
Heat Exchanged, W: 22635
NTU Value: 1.99
mc minimum, W/K: 2515.00
mc maximum, W/K: 4115.60
Effectiveness: 0.7500

DO YOU WISH TO RUN THE PROGRAM USING DIFFERENT CONDITIONS <y/n>?

```

重複範例 4-13，熱交換面積由 20 m² 間隔 20 m² 增加到 200 m²，試探討不同的熱交換器面積對於系統設計的影響。

Area, m ²	Limiting	UA, W/K	m _{water}	water t _{exit}	NTU	ε
20	solution does not converge					
40	cold side	2000	3.4837	33.446	0.80	0.5294
60	warm side	3000	0.5474	25.107	1.31	0.5819
80	warm side	4000	0.4110	21.826	2.33	0.7749
100	warm side	5000	0.3669	20.243	3.26	0.8681
120	warm side	6000	0.3468	19.386	4.14	0.9185
140	warm side	7000	0.3361	18.887	4.98	0.9479
160	warm side	8000	0.3298	18.581	5.80	0.9658
180	warm side	9000	0.3260	18.387	6.61	0.9772
200	warm side	10000	0.3235	18.262	7.39	0.9846

重複範例 4-13，如果是平行流 (parallel flow) 的熱交換器，重複上題，面積由 60 m²，增加到 200 m²，試探討反向流與平行流熱交換器的差異？

Area, m ²	Limiting	UA	m _{water}	Water t _{exit}	NTU	ε
60	Cold	3000	0.979	29.482	1.19	0.5294
100	Cold	5000	0.7144	27.48	1.99	0.5294
140	Cold	7000	0.6831	27.092	2.78	0.5294
200	Cold	10000	0.6761	27.01	3.98	0.5294

第四章 作業

1. Exercise 1 on p139 of Textbook.
2. Exercise 8 on p140 of Textbook
3. 算完後請分別使用 RVALUE 與 XCHANGER 兩程式進行驗證，並將最後結果直接由螢幕上剪貼印出。
4. 中報告新增選擇：建立 MATLAB 版本的 RVALUE 程式。
5. 期中報告新增選擇：建立 MATLAB 版本的 XCHANGER 程式。